

Overviews

OSA 2 core faceplate is widely applied in the FTTX network . Can be multi-use to achieve a variety of fiber optic cable in multi-mode access , and fixed fiber optical cable . It supports splicing ,distribution , mechanical connection and wall mounted installation . The capacity of this box can be 1 core ,2 core.









Feature

- Two cooling fans for longspan performance
- Compatible with fo adapter or fast connectors
- Easy installations: Mount on wall
- ABS material with good quality
- Compatible with $\Phi 0.2$ - $\Phi 3.0$ mm pigtail & 3.1 x 2.0 mm indoor drop cable

Specification

Item	Parameter
Dimension	86*86*23mm
Drop Cable(flat)	Indoor flat drop cable 2*3mm
Drop Cable(round)	4 pieces
Diameter of fiber cable	$\Phi 5$ mm~ $\Phi 10$ mm
Tensile Strength	>50N
Operation Temperature	-40~ + 75℃
Optional Accessories	Adapters ,Pigtails , Heat Shrink Tubes
Shipping Information	
Package Contents	1pcs box and accessory
Packing Way	500pcs/ctns
Lead time	8~15 days

Main Accessory

Standard				Optional	
					
OSA box	Heat shrink tube	Swelling screw	Screw	Fiber Pigtail	Fiber Adapter

Order Information

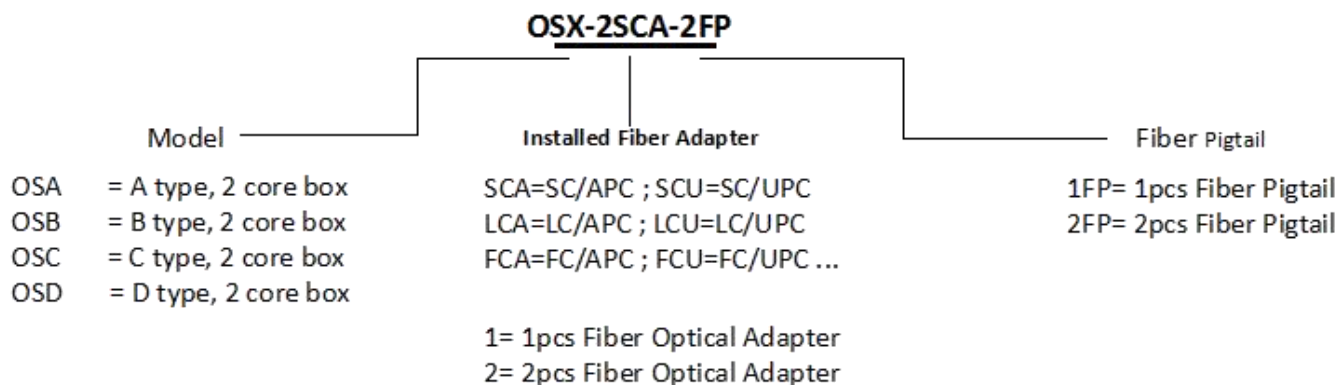

For example : OSA-2SCA-2FP , A type 2 core box , installed 2pcs SC/APC Adapter and Pigtail



We produce a wide selection of network equipment under HONDAO brand . Gather thousands of products ,which are supplier to customs of differnt filed and different requirement . QC team test all goods before shipment . We screen the Chinese supplier in a search of the most efficient product solutions available to satisfy your individual needs.